

# BUSHRANGER

4x4 GEAR

5 YEAR  
WARRANTY



## NIGHT HAWK

SINGLE ROW LED LIGHT BAR

VLI  
SERIES

VARIABLE LIGHT INTENSITY

OWNERS MANUAL

NHT LIGHT BARS

# **BUSHRANGER**

**4x4 GEAR**

Congratulations on your purchase of the Bushranger® Night Hawk® Single Row Light Bar. To take full advantage of this product, please read this manual carefully before using. Retain this manual for future reference for installation and warranty.

# Specifications

## General Specifications

|                    |  |
|--------------------|--|
| VOLTAGE RANGE      | 10-30VDC   |
| LED TYPE           | Genuine OSRAM LED's  |
| COLOUR TEMPERATURE | 5700K  |
| CONTROL PLUG       | 4 pin custom (use with VLI Wiring System, sold separately) |
| COMPLIANCE         | CE, UNECE R10, IP67 & IP69K, ROHS                          |
| COLOUR TEMPERATURE | 5700K  |

## Individual Specifications

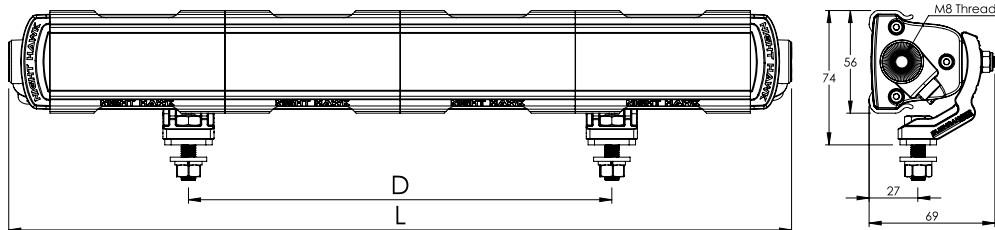

| Part Number | Nominal Size | LED Quantity | Current Draw (@14.4V) | Power Draw | Effective Lumens | Power Plug  | Qty of Covers Supplied    | Qty of Mounting Feet Supplied | Overall Weight | Dimensions         |                                      |
|-------------|--------------|--------------|-----------------------|------------|------------------|-------------|---------------------------|-------------------------------|----------------|--------------------|--------------------------------------|
|             |              |              |                       |            |                  |             |                           |                               |                | Overall Length (L) | Mounting Hole Adjustment Range (D) * |
| NHT055VLI   | 5.5"         | 3            | 0.9A                  | 13W        | 910              | Deutsch DT  | 1 x Flood<br>1 x Diffused | 1                             | 0.50kg         | 141mm              | -                                    |
| NHT130VLI   | 13"          | 9            | 2.7A                  | 39W        | 2750             | Deutsch DT  | 3 x Spot<br>3 x Flood     | 2                             | 1.10kg         | 333mm              | Up to 258mm                          |
| NHT170VLI   | 17"          | 12           | 3.6A                  | 52W        | 3670             | Deutsch DT  | 4 x Spot<br>4 x Flood     | 2                             | 1.35kg         | 429mm              | Up to 354mm                          |
| NHT205VLI   | 20.5"        | 15           | 4.4A                  | 63W        | 4590             | Deutsch DT  | 5 x Spot<br>5 x Flood     | 2                             | 1.60kg         | 525mm              | Up to 450mm                          |
| NHT245VLI   | 24.5"        | 18           | 5.4A                  | 78W        | 5510             | Deutsch DT  | 6 x Spot<br>6 x Flood     | 2                             | 1.85kg         | 621mm              | Up to 546mm                          |
| NHT280VLI   | 28"          | 21           | 6.3A                  | 90W        | 6420             | Deutsch DT  | 7 x Spot<br>7 x Flood     | 2                             | 2.10kg         | 717mm              | Up to 642mm                          |
| NHT320VLI   | 32"          | 24           | 7.1A                  | 102W       | 7340             | Deutsch DT  | 8 x Spot<br>8 x Flood     | 2                             | 2.35kg         | 813mm              | Up to 738mm                          |
| NHT395VLI   | 39.5"        | 30           | 9.0A                  | 129W       | 9180             | Deutsch DT  | 10 x Spot<br>10 x Flood   | 3                             | 3.00kg         | 1005mm             | ** Up to 930mm                       |
| NHT435VLI   | 43.5"        | 33           | 9.8A                  | 141W       | 10100            | Deutsch DTP | 11 x Spot<br>11 x Flood   | 3                             | 3.25kg         | 1101mm             | ** Up to 1026mm                      |
| NHT510VLI   | 51"          | 39           | 11.8A                 | 170W       | 11940            | Deutsch DTP | 13 x Spot<br>13 x Flood   | 3                             | 3.75kg         | 1292mm             | ** Up to 1218mm                      |

\*When using mounting feet, all mounting feet supplied must be used, be fitted symmetrically about the centre of the light and positioned towards the ends of the light bar to reduce overhang.

\*\*Mounting hole adjustment range listed is the maximum distance that the two outer sliding feet can be adjusted apart. Where a third mounting foot is supplied, it should be mounted in the centre.

# Overview

Bushranger® Night Hawk Single Row LED Light Bars have been developed from the ground up by our team of engineers to offer a compact and low-profile design which takes performance, looks and usability to a whole new level.

The clean, modern aesthetic incorporates quality materials and construction and provides a unique and versatile mounting system that makes installation a breeze. The Advanced Temperature Control System takes advantage of the quality aircraft grade aluminium heatsink to run the LED's at their maximum potential by monitoring and adjusting the output according to the environment.

These lights are so bright, we've also incorporated a brightness control function which allows complete control of the light intensity in adverse conditions, where too much light can be detrimental to clear vision. The brightness is controlled by our pioneering, relay-free VLI series wiring system, which is the first of its kind, and leads the way with simpler wiring, easier installation, more user control and greater reliability over traditional systems.

For 5.5" lights, each is supplied with two protective covers, a Flood Beam and a Diffused Beam, which allow quick and easy customisation of the beam pattern to suit any requirement. Clip on the Diffused protective cover to experience a dedicated work light beam pattern, which provides a smooth, indirect wall of light over the immediate work area for excellent, short distance illumination. Change over to the flood protective cover to achieve a wide, flood beam pattern which lights up all the surroundings for excellent medium distance vision. Remove the covers completely to achieve a clean, focused Spot Beam pattern which reaches incredible distance for a small, compact light.

For lights 13" and above, each is supplied with a full set of protective spot beam covers plus a full set of protective flood beam covers, which allow quick and easy customisation of the beam pattern to suit any requirement. With the spot protective covers fitted, the light projects a clean, focused spot beam pattern which reaches extreme distance; great for highway driving. Clip on the flood protective covers and the light changes significantly to a wide, flood beam pattern which illuminates all the surroundings for excellent short to medium distance vision. Run any combination of each cover to tailor the perfect combo beam pattern for the environment.

Bushranger® Night Hawk lights are engineered tough to withstand the rugged outdoor terrain and harsh climate experienced down under. They are backed by a 5 year warranty and our 40+ year history of supplying quality engineered 4x4 products to the Australian market.

## Key Features

### High Output OSRAM LED's

- Genuine, high output OSRAM LED's produce huge effective lumens outputs for each size in the range.
- Unrivaled 1lux distance and width performance for slimline single row light bars
- Tested by an Australian NATA accredited photometry lab to produce real light performance data.

### Active Temperature Control System

- Intelligent onboard monitoring of the LED temperatures, combined with a quality heatsink design, allows for maximum output in all conditions.

### Modern Electronics Design

- Built in Transistor switching simplifies wiring installation by removing the need for traditional 12V relays.
- PWM dimming capability for brightness control at the turn of a dial
- Over voltage and Reverse Polarity Protection.

### Changeable Beam Pattern

- Full set of clip on/clip off spot beam and flood beam protective covers for 13" and up lights allows for complete customization of beam pattern
- 5.5" light supplied with Diffused and Flood covers for more versatile work light options, or remove cover completely for a dedicated Spot beam pattern.

### Built Tough

- Extruded, 6061 aircraft grade aluminium housing and cast alloy mounting feet offers long term strength and durability.

### Durable Exterior

- UV stable polyester powder coat, polycarbonate lens and covers ensure long term durability to handle even the toughest Australian conditions.

### Sealed Tight

- Waterproof and submersible, IP67 & IP69K rated with Genuine GORE breather, to manage the internal air pressure of the light.

### Versatile Installation

- Lightweight and low-profile design with highly adjustable sliding mounting feet allows for diverse fitment.

## Light Performance

| Part Number | SIZE  | Full set of Spot Covers |                               | Full set of Flood Covers                                   |   |
|-------------|-------|-------------------------|-------------------------------|--|---|
|             |       | Max Distance @ 1lux     | Max Primary Beam Width @ 1lux | Max Distance @ 1lux  | Max Primary Beam Width @ 1lux                             |
| NHT055VLI   | 5.5"  | 267m                    | 15m                           | 126m<br>(with Flood Cover)<br>43m<br>(with Diffused Cover) | 39m<br>(with Flood Cover)<br>20m<br>(with Diffused Cover) |
| NHT130VLI   | 13"   | 462m                    | 26m                           | 218m   | 69m   |
| NHT170VLI   | 17"   | 534m                    | 30m                           | 252m   | 79m   |
| NHT205VLI   | 20.5" | 597m                    | 34m                           | 282m   | 89m   |
| NHT245VLI   | 24.5" | 654m                    | 38m                           | 309m   | 96m   |
| NHT280VLI   | 28"   | 706m                    | 40m                           | 334m   | 105m  |
| NHT320VLI   | 32"   | 755m                    | 43m                           | 357m   | 112m  |
| NHT395VLI   | 39.5" | 844m                    | 48m                           | 399m   | 125m  |
| NHT435VLI   | 43.5" | 886m                    | 51m                           | 418m   | 132m  |
| NHT510VLI   | 51"   | 963m                    | 55m                           | 454m   | 143m  |

# Isolux Data

All results shown below are obtained from real scientific testing carried out by a NATA Accredited Photometric Laboratory in Australia.

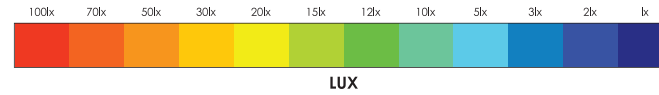

**NATA** ACTUAL PHOTOMETRIC TEST DATA  
PERFORMED BY NATA  
ACCREDITED LABORATORY  
IN AUSTRALIA

## NHT055VLI (5.5") – SPOT BEAM (NO COVER FITTED)

Max distance @ 1lux = 267m | Max Primary Beam Width @ 1lux = 15m

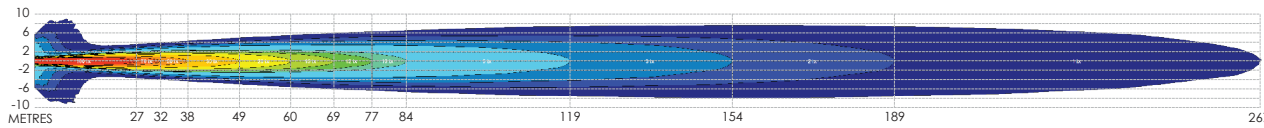

## NHT055VLI (5.5") – 1 x DIFFUSED COVER

Max distance @ 1lux = 43m | Max Primary Beam Width @ 1lux = 20m

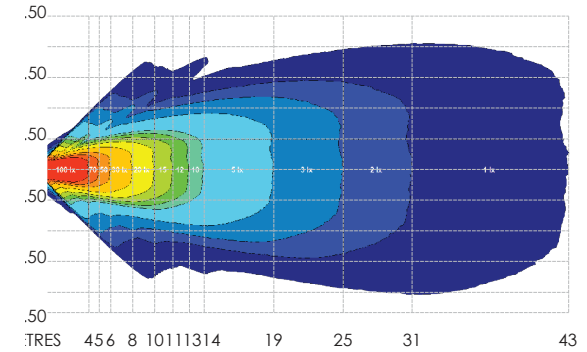

## NHT055VLI (5.5") – 1 x FLOOD COVER

Max distance @ 1lux = 126m | Max Primary Beam Width @ 1lux = 39m

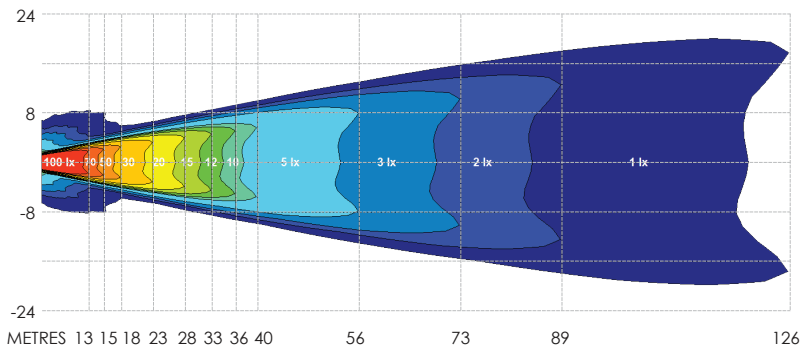

## NHT130VLI (13") – 3 x FLOOD BEAM COVERS

Max distance @ 1lux = 218m | Max Primary Beam Width @ 1lux = 69m

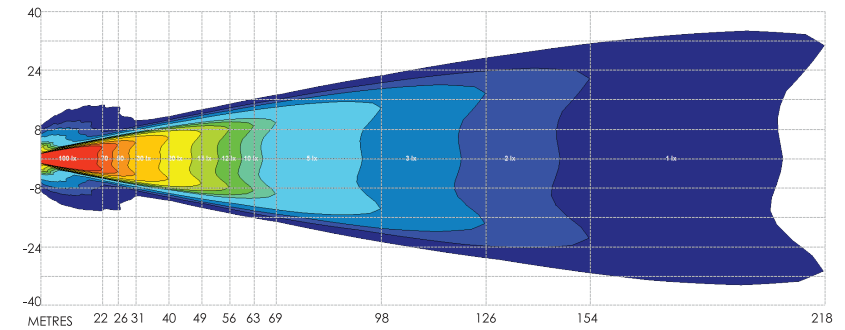

## NHT130VLI (13") – 3 x SPOT BEAM COVERS

Max distance @ 1lux = 462m | Max Primary Beam Width @ 1lux = 26m

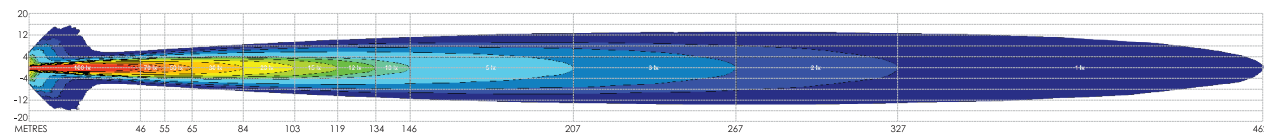

# Isolux Data

All results shown below are obtained from real scientific testing carried out by a NATA Accredited Photometric Laboratory in Australia.

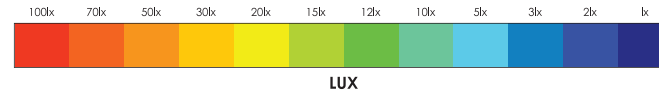

## NHT170VLI (17") – 4 x SPOT BEAM COVERS

Max distance @ 1lux = 534m | Max Primary Beam Width @ 1lux = 30m

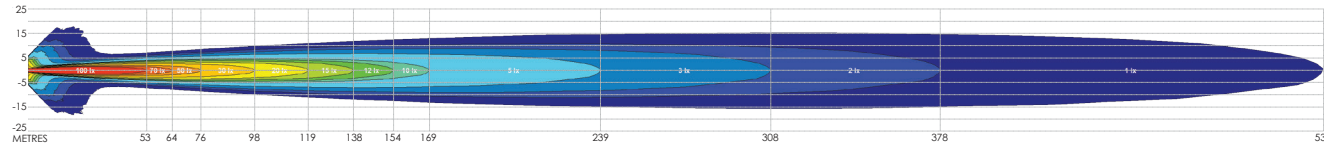

## NHT170VLI (17") – 4 x FLOOD BEAM COVERS

Max distance @ 1lux = 252m | Max Primary Beam Width @ 1lux = 79m

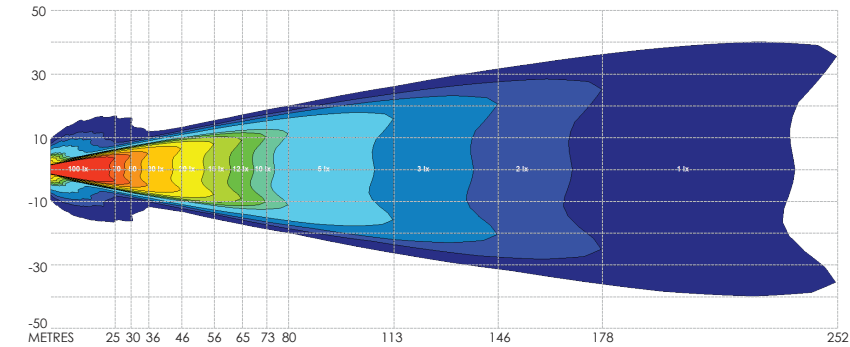

## NHT205VLI (20.5") – 5 x SPOT BEAM COVERS

Max distance @ 1lux = 597m | Max Primary Beam Width @ 1lux = 34m

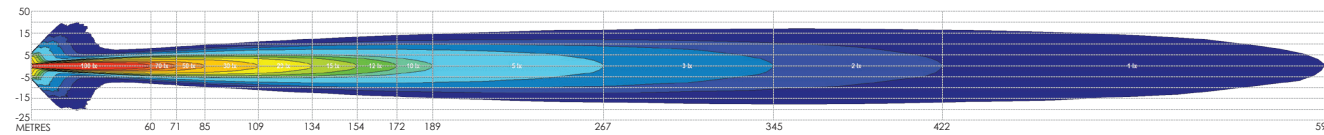

## NHT205VLI (20.5") – 5 x FLOOD BEAM COVERS

Max distance @ 1lux = 282m | Max Primary Beam Width @ 1lux = 89m

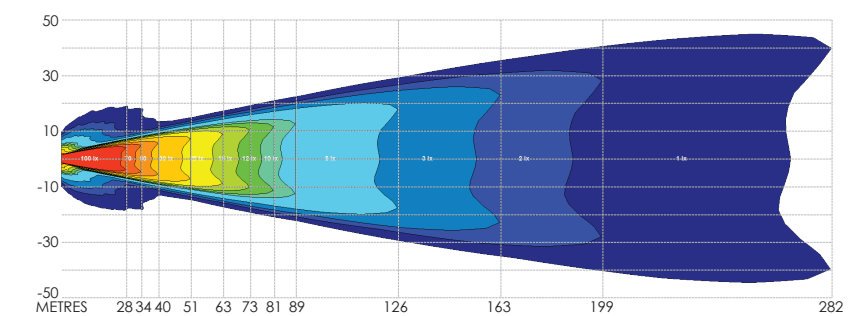

## NHT245VLI (24.5") – 6 x SPOT BEAM COVERS

Max distance @ 1lux = 654m | Max Primary Beam Width @ 1lux = 38m

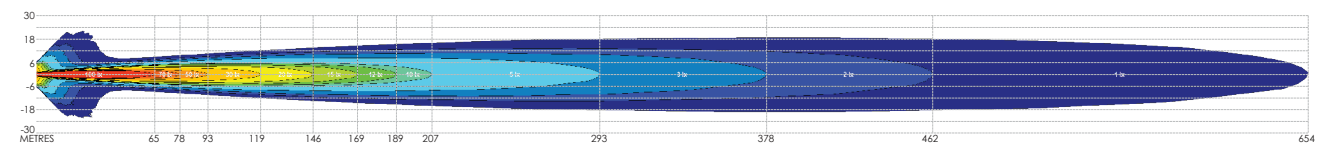

## NHT245VLI (24.5") – 6 x FLOOD BEAM COVERS

Max distance @ 1lux = 309m | Max Primary Beam Width @ 1lux = 96m

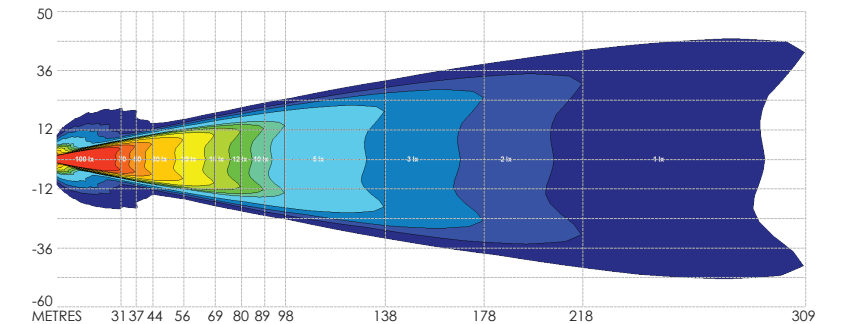

# Isolux Data

All results shown below are obtained from real scientific testing carried out by a NATA Accredited Photometric Laboratory in Australia.

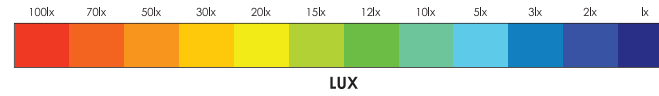

## NHT280VLI (28") – 7 x SPOT BEAM COVERS

Max distance @ 1lux = 706m | Max Primary Beam Width @ 1lux = 40m

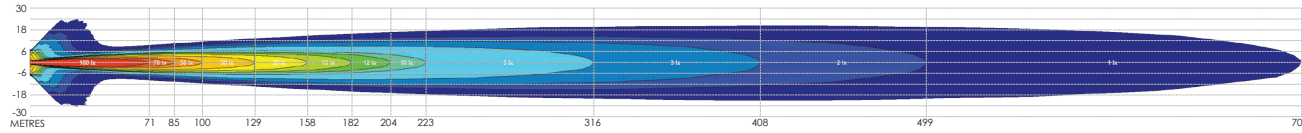

## NHT280VLI (28") – 7 x FLOOD BEAM COVERS

Max distance @ 1lux = 334m | Max Primary Beam Width @ 1lux = 105m

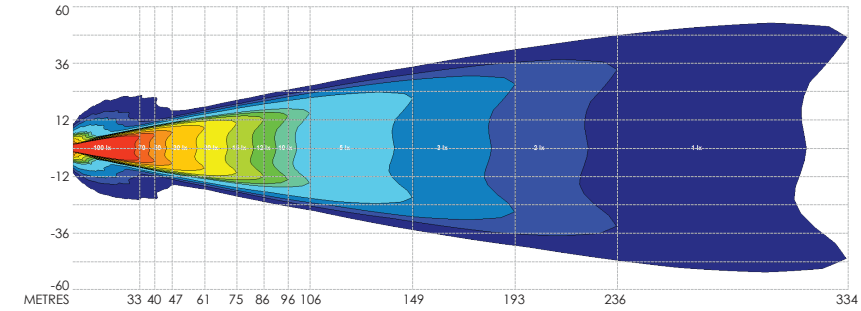

## NHT320VLI (32") – 8 x SPOT BEAM COVERS

Max distance @ 1lux = 755m | Max Primary Beam Width @ 1lux = 43m

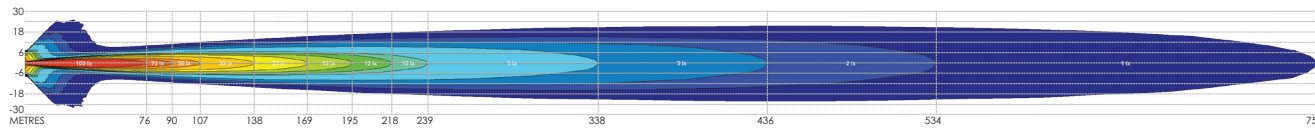

## NHT320VLI (32") – 8 x FLOOD BEAM COVERS

Max distance @ 1lux = 357m | Max Primary Beam Width @ 1lux = 112m

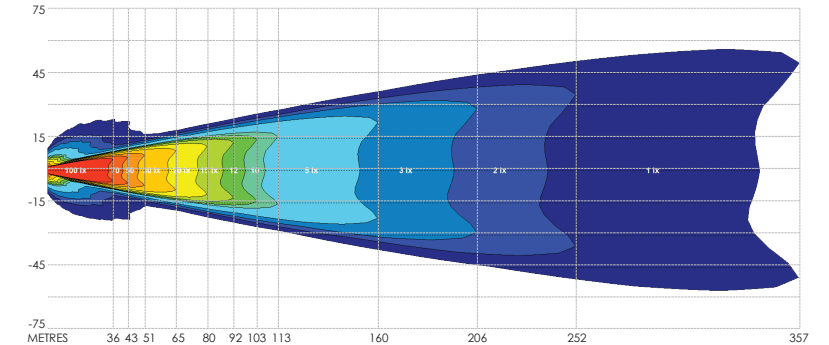

## NHT395VLI (39.5") – 10 x SPOT BEAM COVERS

Max distance @ 1lux = 844m | Max Primary Beam Width @ 1lux = 48m

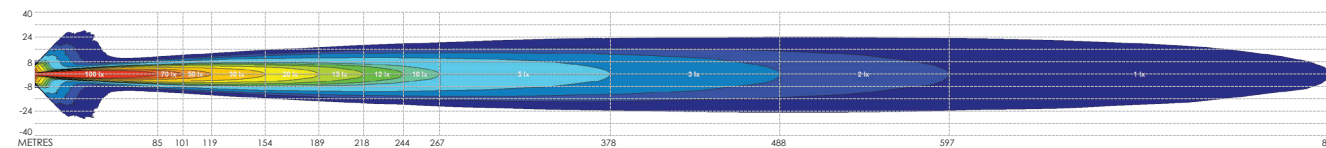

## NHT395VLI (39.5") – 10 x FLOOD BEAM COVERS

Max distance @ 1lux = 399m | Max Primary Beam Width @ 1lux = 125m

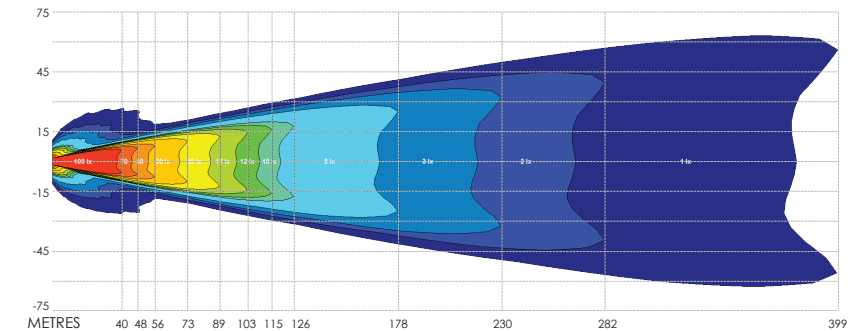

# Isolux Data

All results shown below are obtained from real scientific testing carried out by a NATA Accredited Photometric Laboratory in Australia.

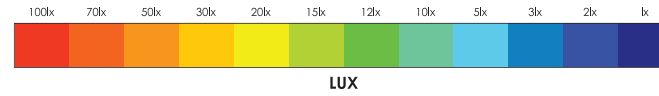

**NATA** ACTUAL PHOTOMETRIC TEST DATA  
PERFORMED BY NATA  
ACCREDITED LABORATORY  
IN AUSTRALIA

## NHT435VLI (43.5") – 11 x SPOT BEAM COVERS

Max distance @ 1lux = 886m | Max Primary Beam Width @ 1lux = 51m

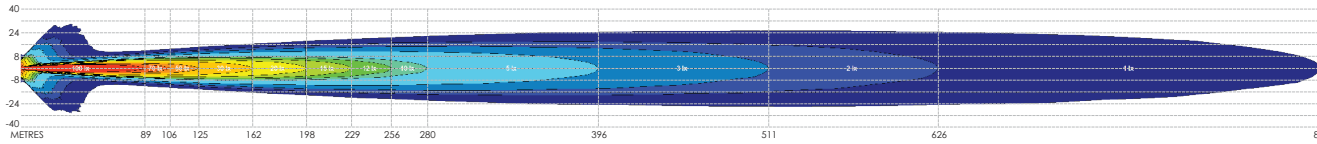

## NHT435VLI (43.5") – 11 x FLOOD BEAM COVERS

Max distance @ 1lux = 418m | Max Primary Beam Width @ 1lux = 132m

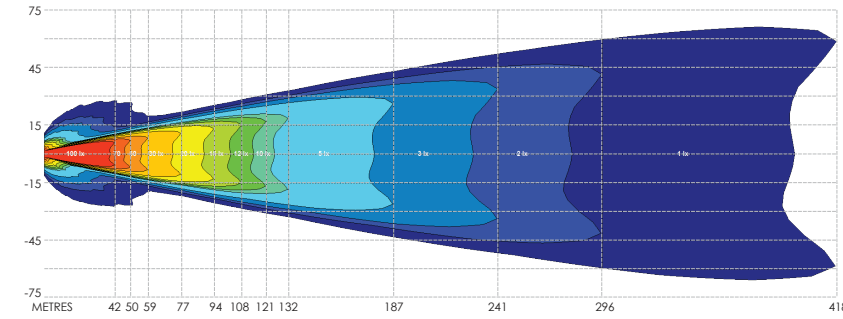

## NHT510VLI (51") – 13 x SPOT BEAM COVERS

Max distance @ 1lux = 963m | Max Primary Beam Width @ 1lux = 55m

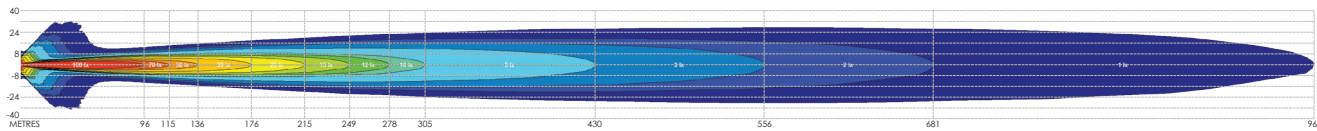

## NHT510VLI (51") – 13 x FLOOD BEAM COVERS

Max distance @ 1lux = 454m | Max Primary Beam Width @ 1lux = 143m

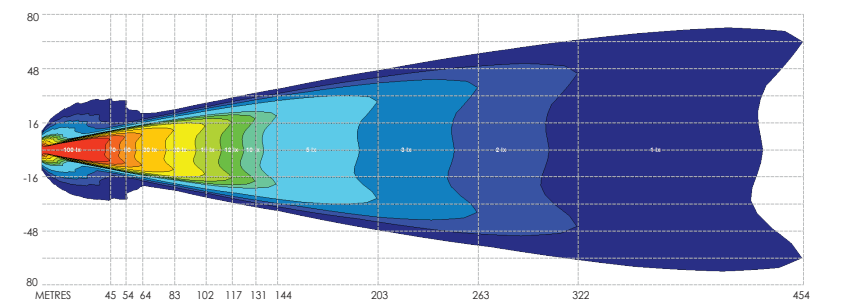



## Components Supplied

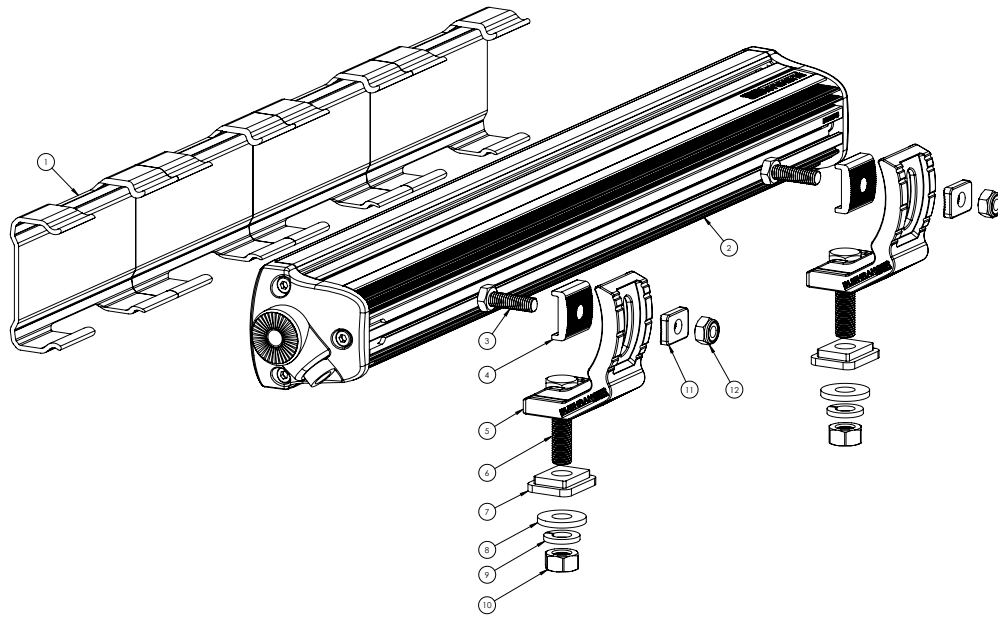

| Item# | Component Name                          |
|-------|---|
| 1     | Protective Covers                       |
| 2     | NHT Light Bar                           |
| 3     | M6x20mm Hex Bolt                        |
| 4     | Mount Adaptor                           |
| 5     | Mounting Foot                           |
| 6     | M8x30mm Hex Bolt                        |
| 7     | Rubber Isolator                         |
| 8     | M8 Flat Washer                          |
| 9     | M8 Spring Washer                        |
| 10    | M8 Hex Nut                              |
| 11    | Radius Washer                           |
| 12    | M6 Nyloc Nut                            |
| 13    | Power Lead 2.5m with fuse (Not Shown)   |
| 14    | Anti-Seize Lubricant Sachet (not shown) |

## Installation Instructions

### Important Notes

- We recommend the lights / wiring to be fitted by a qualified automotive electrician.
- A forward facing light system may be used only as an auxiliary to high beam. Check compliance and regulations with local authorities.
- Vehicle accessories mounted on the outside of the vehicle may need to comply with regulations governed by your local state authority. Please check before installation.
- When mounting lights, position them appropriately so they do not obstruct existing automotive function. If fitting to front of vehicle, check for Bonnet clearances.
- Consideration should be given for airflow requirements of the vehicle and its mechanical components when mounting lights.
- All stainless steel hardware must have anti-seize applied to the threads before tightening to avoid binding or galling of components.
- Ensure all recyclable Parts/Packaging are discarded in accordance to local regulations.

### Light Mounting Feet

The NHT Light Bar series have been designed to offer a highly adaptable mounting arrangement. The light mounting feet can be slid along the body of the light bar and rotated a full 200° around to suit the majority of mounting applications.

The mounting feet supplied with each light bar can be fitted to the rear or underside sliding channels incorporated into the light bar body. Slide the head of the M6x20mm Hex Bolt (Item 3) into the selected channel by inserting it through the opening at one end of the body (marked with red arrows below). The remaining components can then be assembled onto the bolt to secure the mounting foot to the light bar.

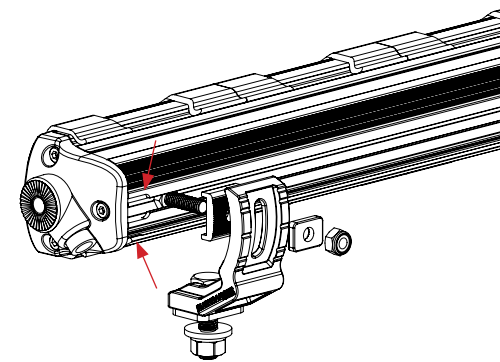

## Angle Adjustment

The mounting feet can be moved through 200° rotation by utilising the two individual channels in the body of the light bar and the two hole positions in the mounting feet. All configurations shown below:

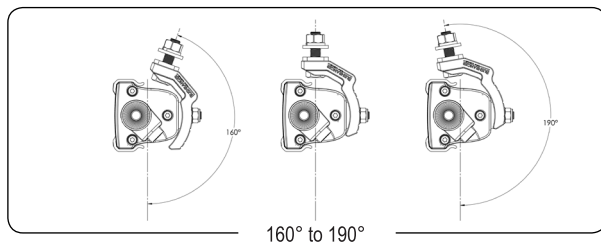
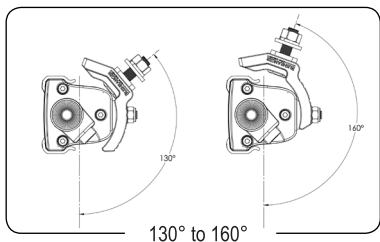
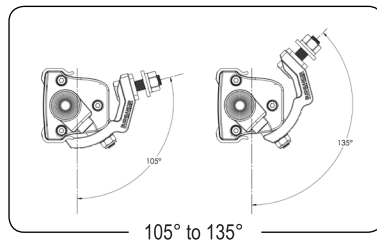
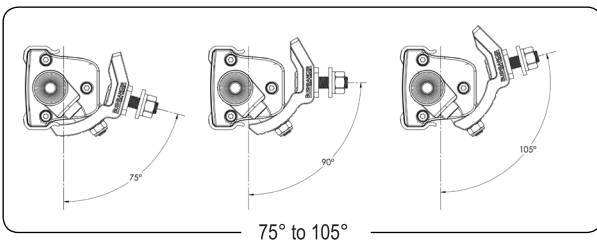
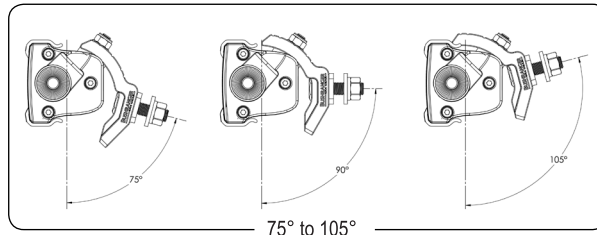
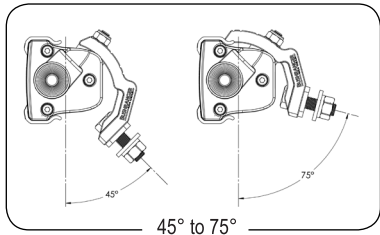
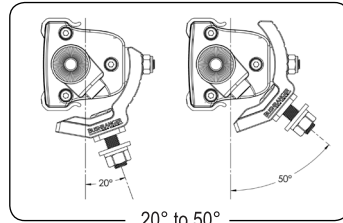
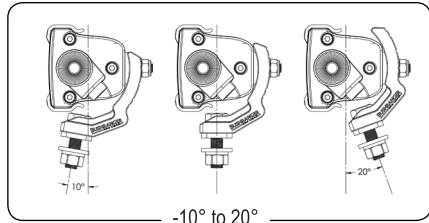

## Vehicle Mounting & Adjustment

Light bars can be mounted using the supplied mounting feet or tube clamps are available (sold separately) for bar mounting applications. When using mounting feet, all mounting feet supplied must be used, be fitted symmetrically about the centre of the light and positioned towards the ends of the light bar to reduce overhang.

Ensure the mounting location for fitment of the light/s to the vehicle is flat, stable, sufficiently strong and has enough clearance around the light to avoid damage to the vehicle from any movement during installation and use. If drilling is required for mounting, ensure raw edges are coated with corrosion resistant paint or inhibitor.

**Apply anti-seize lubricant to the threads before final installation.** The use of anti-seize greatly reduces the risk of thread galling or binding commonly seen between stainless steel nuts and bolts during tightening. Tighten fasteners to the following torque specifications:

### RECOMMENDED TORQUE SETTINGS

|              |      |
|--------------|------|
| M6 Fasteners | 8Nm  |
| M8 Fasteners | 22Nm |

### Wiring Options

The light bars can be wired into the vehicle using 2 methods:

#### 1. VLI Wiring System (P/N: NHW20VLI, available separately)

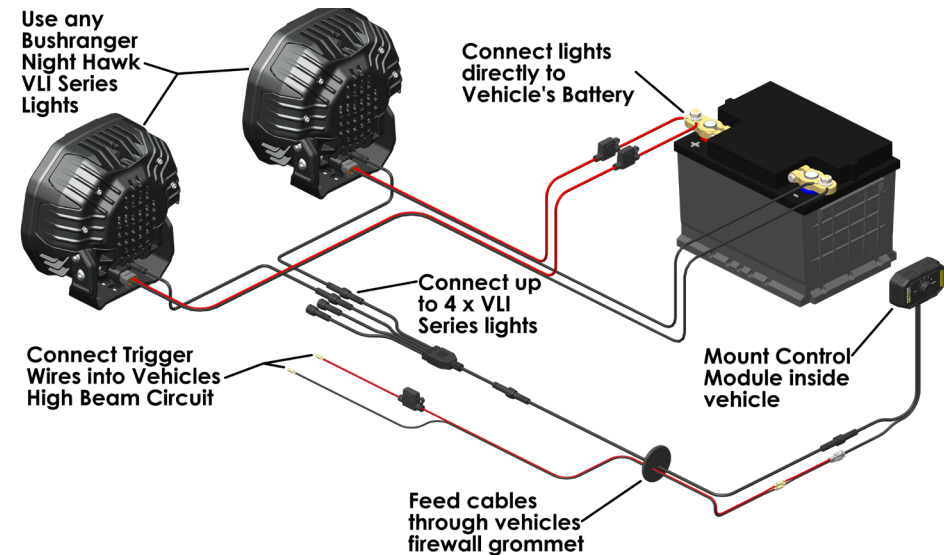

Our unique, relay free Variable Light Intensity Series wiring system greatly simplifies the installation of these light bars into modern vehicles and allows the full functionality of the VLI Series lights to be achieved. Not only is this system easier to install and more reliable than traditional relay-based wiring looms, but it also allows the brightness of all lights connected to be varied, which gives the driver full control of light intensity at the turn of a dial. Up to 4 x VLI Series Lights can be controlled by the one system with no limitations on the power draw of each light.

The VLI Wiring System utilises the 4 pin control plug that comes from the side of the light bars to provide the control signals. The basic principles of operation are: When the control plug is connected to the wiring system, and the power plug is connected directly to the vehicles battery using the supplied power lead, the light will only turn on/off & vary in brightness when signals are received from the in-cabin control module. The in-cabin control module is connected through the vehicles high beam circuit so that the lights can only be operated when the high beam is activated.  
**NOTE:** After installation of the wiring system, the light may briefly flash when first connected to the power source. This is normal operation and not a malfunction.

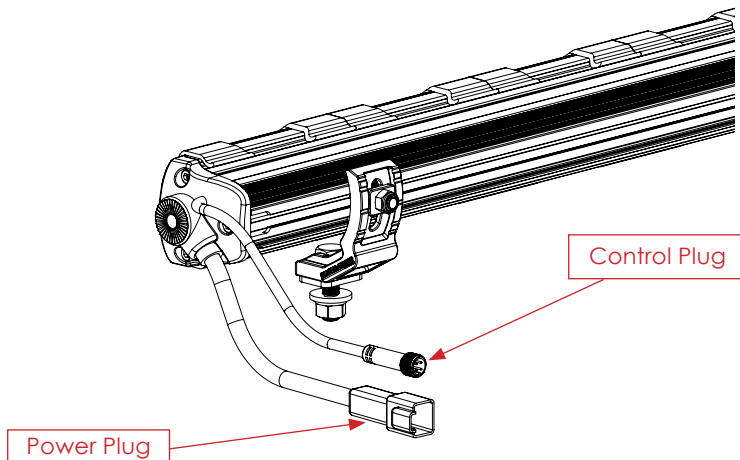

## 2. Traditional Wiring Looms

All VLI Series lights can also be used in a more traditional, 12V relay-based wiring loom / harness setup. Care needs to be taken to ensure that the wiring harness is rated for the high-power requirements of the VLI Series lights.

The basic principles of operation are:  
When the control plug is not used and power is supplied to the power plug, the light will turn on and operate at maximum output. Ensure that the attached sealing cap is fitted to the control plug when not in use.

## Care and Maintenance

- The light is not serviceable – DO NOT disassemble.
- Clean lights using pH neutral soapy water and a soft nonabrasive brush or sponge. Rinse thoroughly after cleaning.
- DO NOT use solvents, Alkaline based cleaners or abrasive materials to clean the light.
- If lights are exposed to a high salt environment or any other corrosive substance, remove the light and mounting bracket from the vehicle and thoroughly clean and rinse the components as outlined above.
- Remove the clear covers periodically to clean any dirt and grime build up.
- Regularly check all fasteners to ensure they are secured and properly torqued.

# Warranty

Kingsley identified below (the Product) will be free from defects in materials and workmanship for the warranty period identified below commencing on the date of purchase from Kingsley ('the Warranty').

Kingsley, will rectify any defect in materials or workmanship appearing within the Warranty period by repairing or replacing the Product (at its option).

Kingsley reserves the right to determine whether the Product contains any defects in materials or workmanship covered by the Warranty.

The benefits offered by this Warranty are in addition to your rights and remedies under the Australian Consumer Law. Our goods come with guarantees that cannot be excluded under the Australian Consumer Law. You are entitled to a replacement or refund for a major failure and for compensation for any other reasonably foreseeable loss or damage. You are also entitled to have the goods repaired or replaced if the goods fail to be of acceptable quality and the failure does not amount to a major failure.

## How to make a warranty claim

A claim under the Warranty must be made within the Warranty period identified below, which commences on the date of purchase from Kingsley. To make a Warranty claim, the Product must be returned to the place of purchase together with proof of purchase unless otherwise agreed by Kingsley.

Any costs incurred in making a Warranty claim or returning a Product to the place of purchase are to be borne by the person making the Warranty claim unless otherwise agreed by Kingsley.

## Exclusions

This Warranty does not cover any defect or injury caused by, or associated with improper installation or maintenance; unauthorised service, repair, modification or alteration; unsuitable physical or operating environment; electrical supply; acts of God; misuse, abuse or neglect; accidental damage, or other alterations or modifications which affect the reliability or performance of the product not attributable to a defect in materials or workmanship.

## Warranty Period

The period in which a defect must appear in a Kingsley Enterprises or Bushranger 4x4 Gear product if the customer is entitled to claim the warranty is 5 years from the date of purchase from Kingsley Enterprises Pty Ltd.

The warranty against defects contained in this document replaces any other warranty against defects or voluntary warranty given in relation to the products.

## Kingsley Enterprises Pty Ltd

6A Brooks Road, Ingleburn 2565  
New South Wales, Australia  
Phone: 1800 654 767  
International: +612 8700 0400  
Email: sales@kingsleyenterprises.com.au

NHTVLI\_LIGHT\_BARS\_MANUAL\_01

# **BUSHRANGER**

---

**4x4 GEAR**

[bushranger.com.au](http://bushranger.com.au)



Free Call | 1800 654 767 (Australia only)

International | +61 2 8700 0400

Fax | +61 2 8700 0499

Email | [sales@kingsleyenterprises.com.au](mailto:sales@kingsleyenterprises.com.au)

Address | 6A Brooks Road, Ingleburn NSW 2565